

# CEILING

## RECESSED TRIM

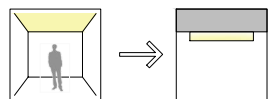



POSSIBLE CUSTOM SHAPES :

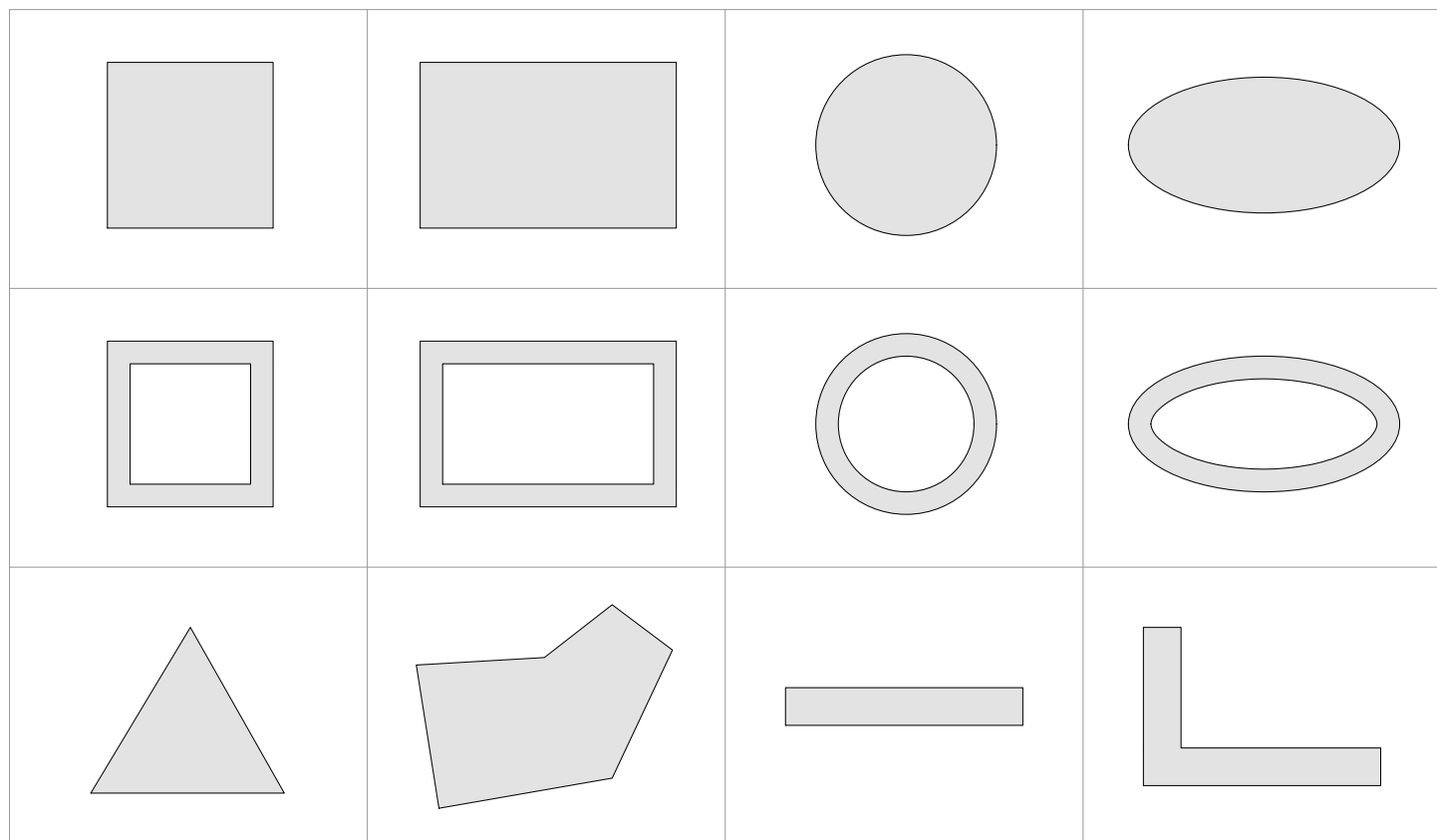

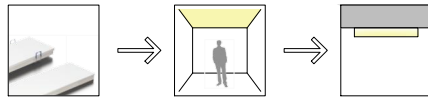

# PRO springs

TYPE OF MOUNTING	RECESSED TRIM	
BACKLIGHT MODEL	<b>PRO</b> 	
MOUNTING SYSTEM	<b>springs</b>	
DIMENSION	MM width 19 - 29 - 34 - 39 - 44 - 54 - 59 - 80 - 104 - 204 mm INCHES width 0.8 - 1.2 - 1.4 - 1.6 - 1.8 - 2.2 - 2.4 - 3.2 - 4.2 - 8.2 in	MM length 101.6 to 3048.0 mm INCHES length 4.0 to 120.0 in

EXAMPLE OF SECTION : 55.88 mm (2.2 in) WIDTH PRO

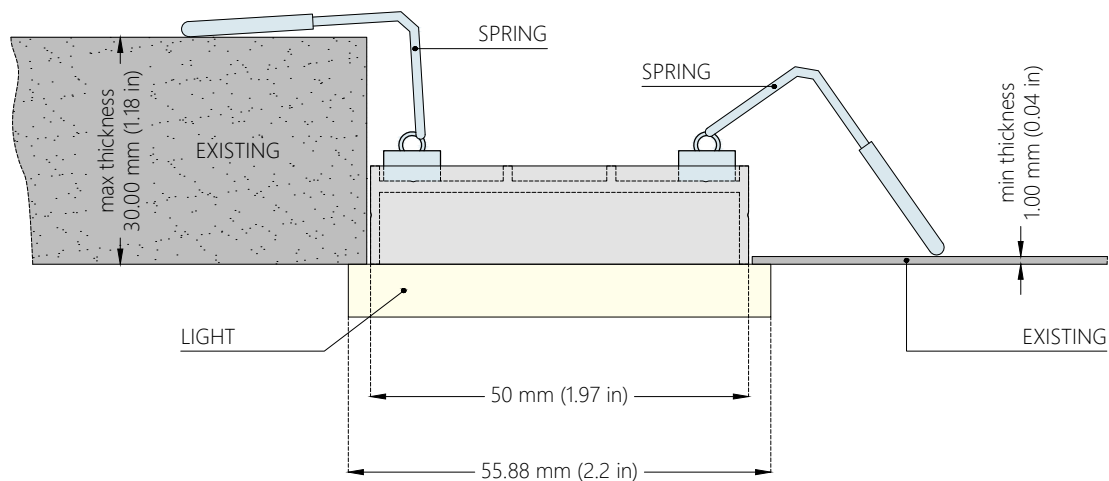

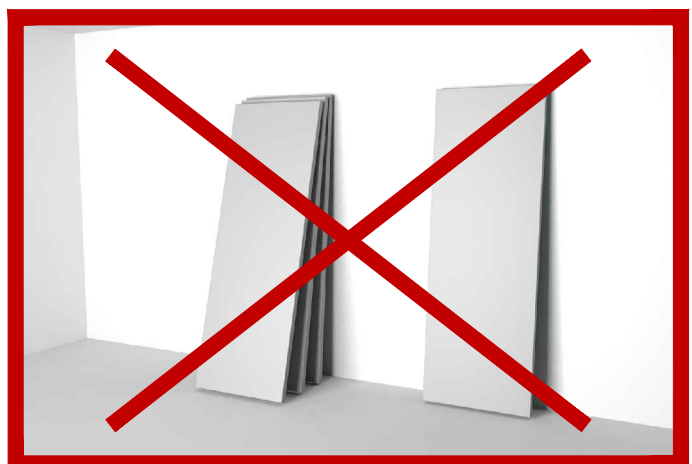
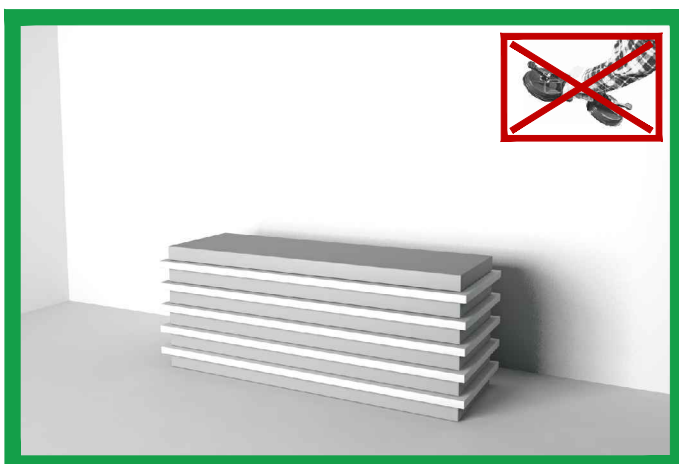
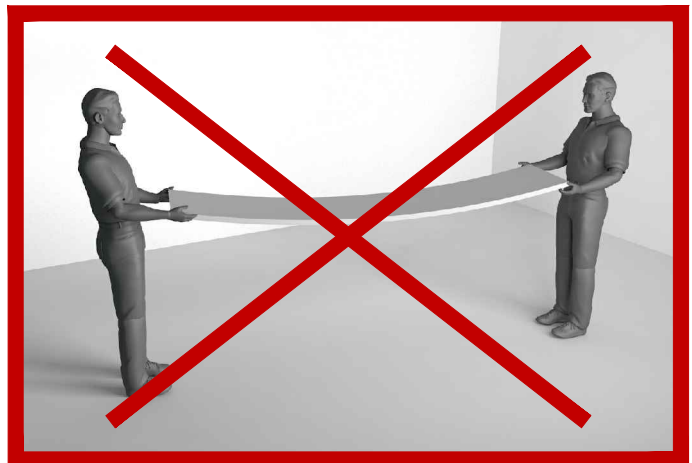
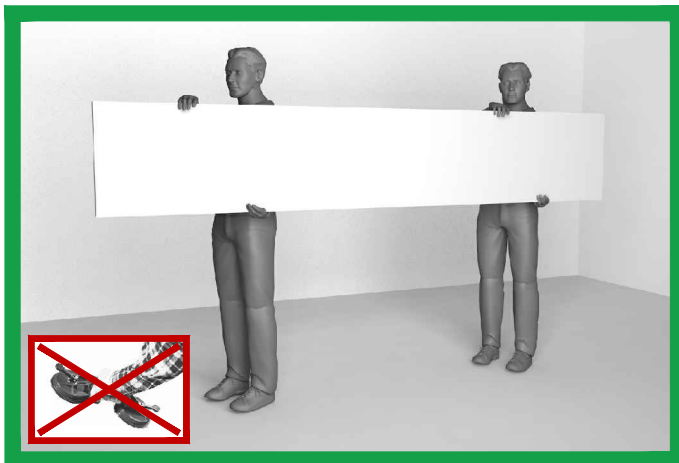
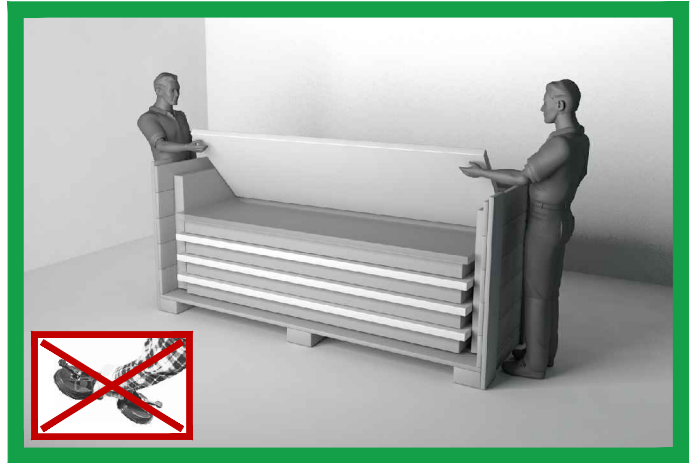

## WARNINGS



DO NOT WET



DO NOT USE DETERGENTS



DO NOT USE HUMID FABRICS